

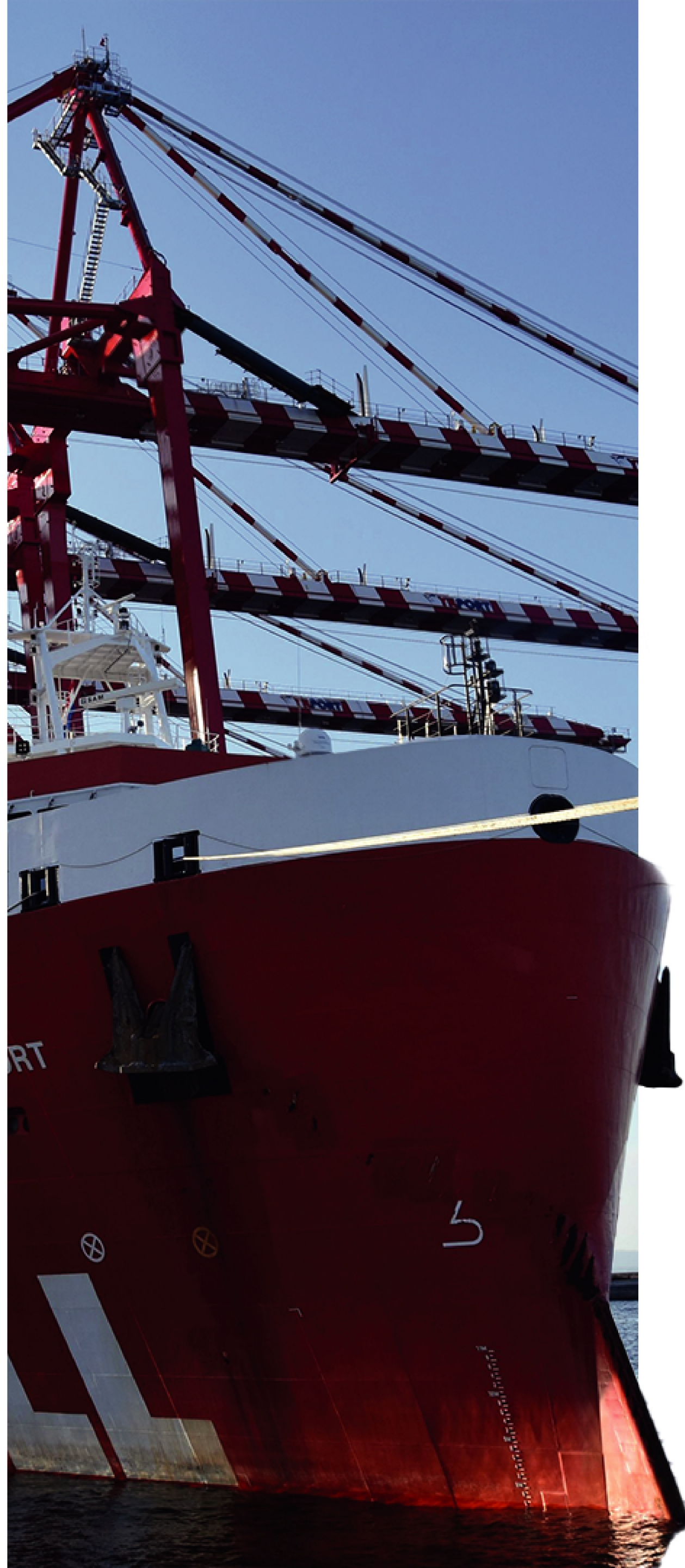

BATI GROUP OF SHIPPING COMPANIES

2023



We have logistics services
in all borders and ports

We are a logistics company
based on shipping,
founded in 1992



Our Headquarters are located
in Istanbul, Türkiye

We provide logistics solutions
to our clients through our own offices
in Turkey, Germany, USA and Italy with
200+ employees

Hinterland

4 COUNTRIES
15 OFFICES
200+ EMPLOYEES



Services

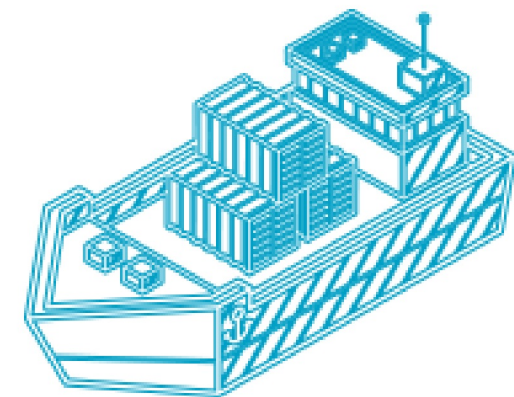

Sea Freight
(FCL/ LCL)

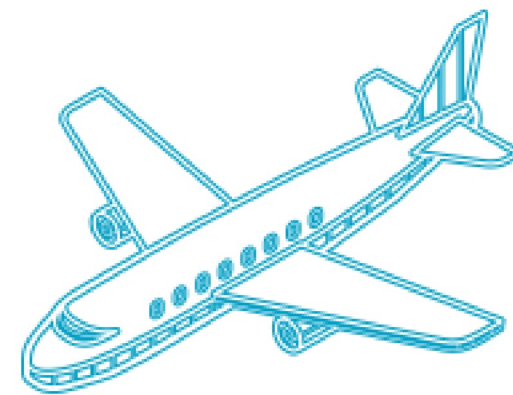

Air Freight and Fast
Delivery Services

BATI **EXPRESS**

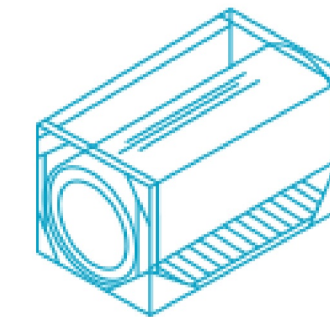

Bulk Liquid
Logistics

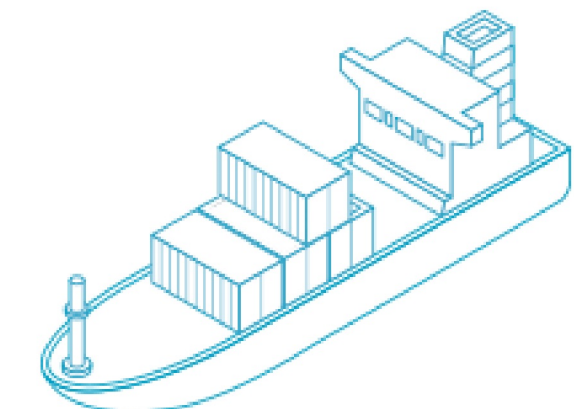

Project Cargo
Forwarding



- Project Cargo Forwarding
- Oil & Gas and Offshore Logistics
- Port Agency Services
- Yacht and Boat Transportation

Tailor Made Industrial Solutions



Project Cargo

BATI has been providing project cargo solutions since its foundation, ensuring its worldwide strength by joining project cargo networks to seek and find the best project cargo agents to cooperate with.

Services:

- Project & Heavy Lift Logistics
- Project Planning
- Route & Port Survey
- Heavy Lift Engineering
- Chartering and Ship Brokerage
- Turnkey Project Management



Offshore Services

Oil & Gas and Renewable Energy

BATI has over 30 years of experience and always strives to offer the highest quality services to Off-Shore sector meeting our Principals needs in a professional and unbiased manner as well as in accordance with local and international regulations.

Our Services including:

- Port Agency Services
- Transportation of Various Equipments.
- Material / Provision Supply
- Custom Clearance
- Crew Change
- Waste Management
- Environment Protection / Pollution Prevention

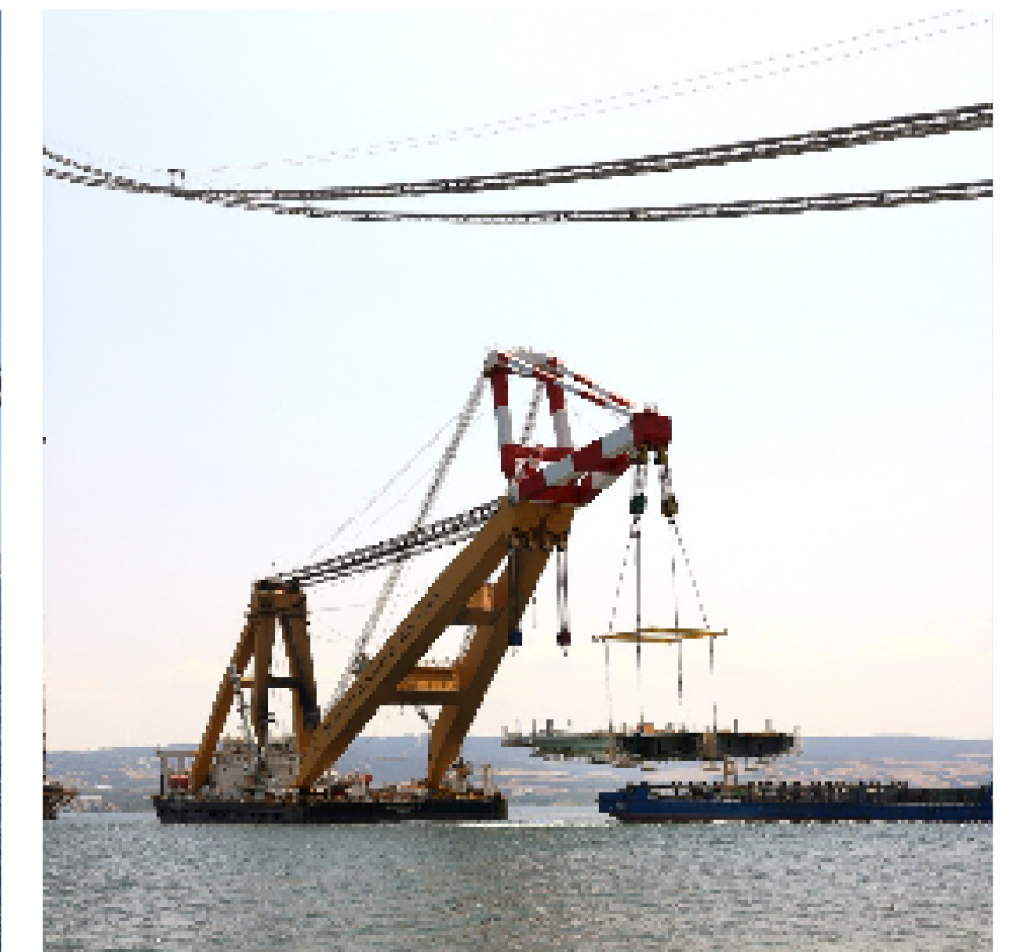
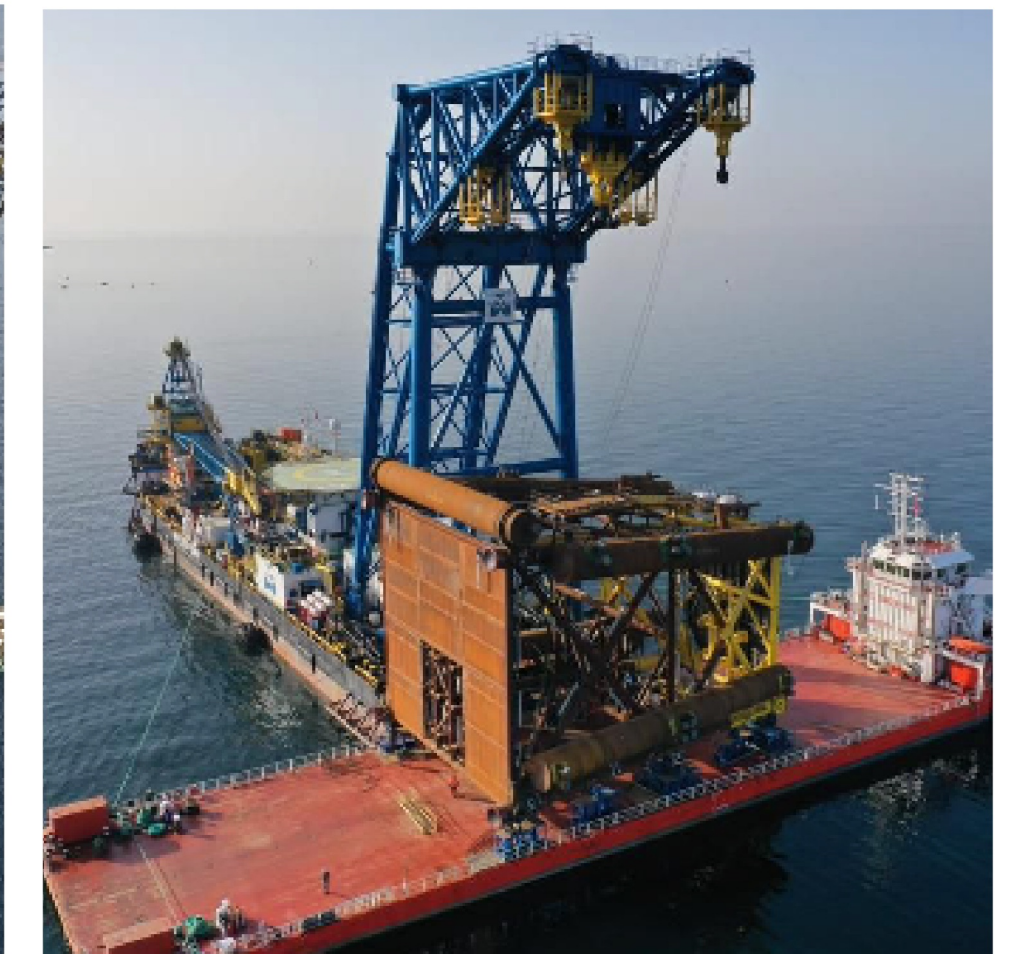

Port Agency Services

BATI is acting as commercial and husbandry Agent for World famous ship owners. ROLLDOCK is one of these exclusive principals which BATI is proud to represent ROLLDOCK both for commercial and husbandry agency services in Türkiye.

ROLLDOCK owns and operates an innovative fleet of highly adaptable project cargo ships. With ROLLDOCK's semi-submersible multifunctional vessels, we can handle a wide variety of situations and circumstances.

As part of Roll Group, ROLLDOCK benefits from in-house essential knowledge and engineering expertise. With over ten years of experience and specially designed vessels, ROLLDOCK ensures the safe transportation of heavy cargo across the world's oceans.

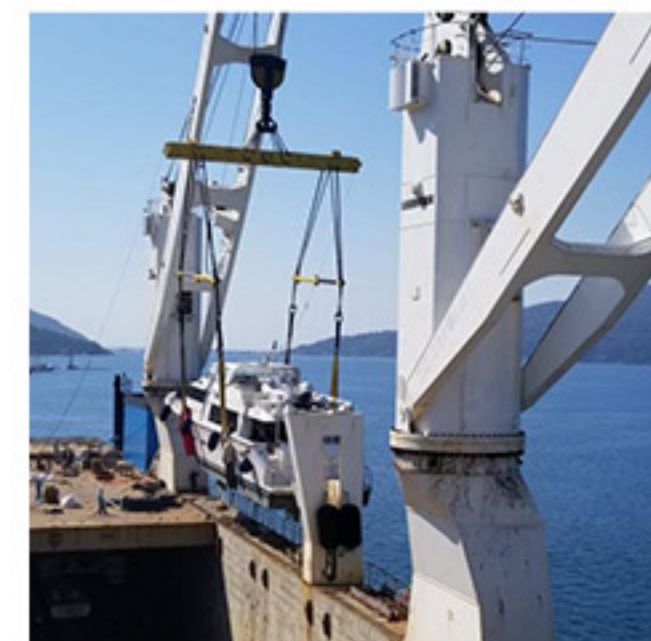
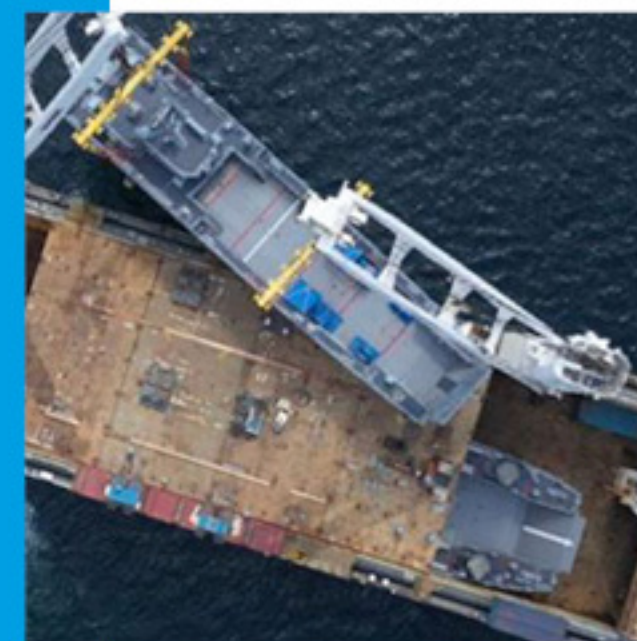
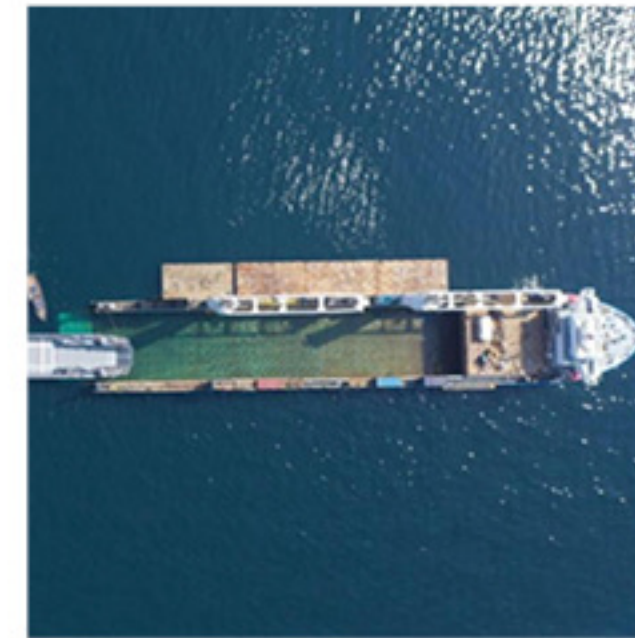

Yacht and Boat Transportation

BATI is acting as the commercial and husbandry agent of **PETERS & MAY**.

PETERS & MAY provide world-leading global yacht transport, car transport, cargo shipping and marine logistics for brokers,

120+ Yachts and Boats transported annually

Industries served;

- Yachts/Boats through brokers and/or shipyards
- Defence Industry / Navy
- Work Boats
- Ferries

Services provided;

- Interational Transportation (Sea and Land)
- Domestic Transportation
- Customs Clearance
- Warehousing
- Cradling
- Skipper

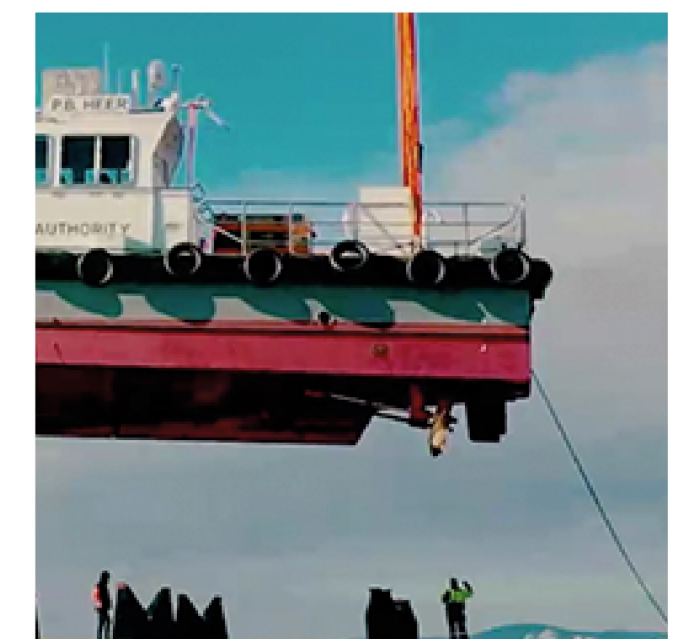
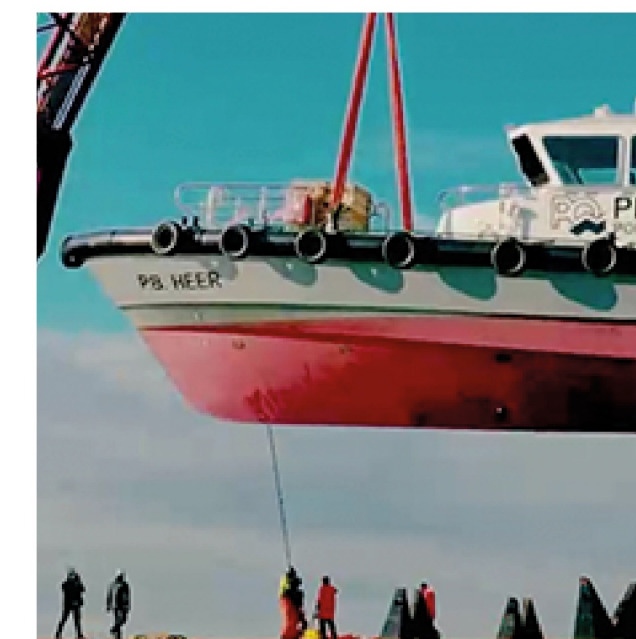

Transit Routes Served

With the increasing importance of TURKIYE in the region, which is a country stationed on a very strategic geographic position, BATI is also capable to organise several cargo types where TURKIYE is considered to be the hub for the transit corridors pictured below;

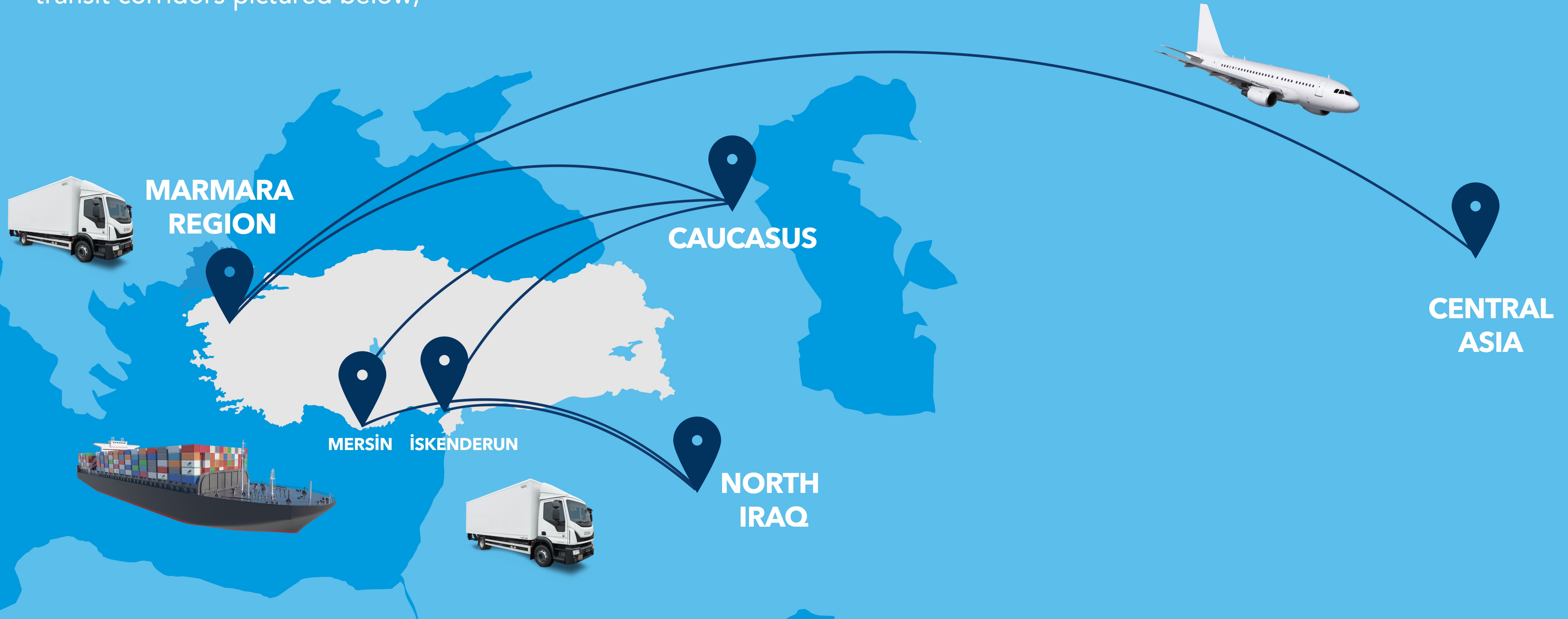



www.batigroup.com.tr



www.batilogistics.it



www.batilogistics.de



www.batiyachtlogistics.com



2023

